

BRU fresca MALTA Piwo Doble  
Ø Stout  
ught Lager  
puma Tap  
ny pub  
除取り除く  
bottle  
NA  
rik  
san  
úpulo  
er  
esca  
ATLIJA  
ut  
TA  
除く  
sa

# PEGAS®

craftap<sup>3</sup>

ТОЧЕЊЕ БЕЗ ПЕНЕ Artisan

Draught Lager

sin espuma

bez piany

pub 取り除く

rzemieślniczy

ТОЧИЛИЦА

pub

craft

Artisan

ТОЧИЛИЦА

Stout

Artisan

úpulo

Пиво

Ale

Tap

bez nena  
hops

Beer

deliciosa

Ø fresca

乾杯

ЗАНАТЛИЈА

BAR

BRIEF MANUAL

The warranty period is 24 months

We welcome your feedback and will review any complaints as to the dispenser's quality at NPM, LLC

**toll-free hotline: 8 (800) 500-73-71**

PO Box 239, Novosibirsk, 630108, Russia.

Tel.: +7 (383) 211-90-49 e-mail: sales@npgroup.ru

# CRAFTAP 3

## Brief Manual on foamy beverages dispensing

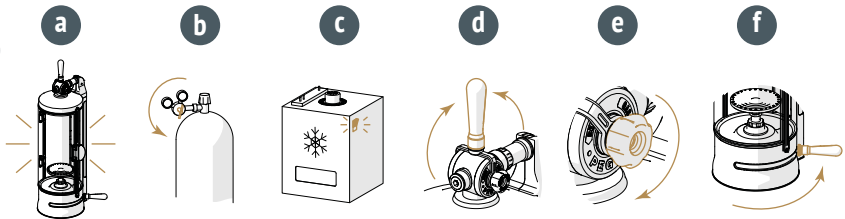

Make sure that the dispenser is ready for use:

- a. is connected to the power supply and the backlight lamps are on;
- b. the gas supply valve on the container is open;
- c. the cooler is on (if being used);
- d. the dispensing assembly handle is upright;
- e. the flow control valve is turned all the way clockwise;
- f. adjust the assembly handle by turning it as far counterclockwise as possible.

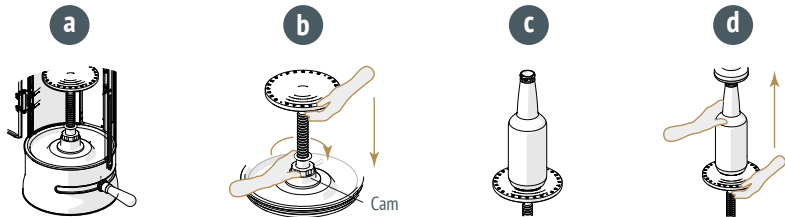

- a. Turn the adjusting assembly knob clockwise until it is in line with the mark on the base;
- b. lower the bottle tray if necessary, depending on the height of the beverage container;
- c. place the beverage container in the center of the bottle tray;
- d. while holding the beverage container with one hand, raise the tray until the neck of the beverage container comes into contact with the rubber gasket.

To lower the tray, turn the cam clockwise with one hand until it stops and, while holding the dish-shaped part of the tray with the other hand, shift it down.

To raise the tray, pull it up holding it with your fingers from underneath.

To avoid hand injury, when lowering the bottle tray:

- do not hold the shaft with your hand.
- do not put your fingers above the cam stopper when turning the cam.



e

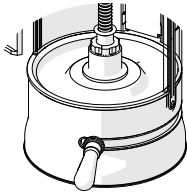

e. press the beverage container tightly against the pouring head by turning the adjusting assembly knob clockwise.

f

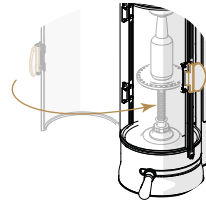

f. close the protective door after first ensuring that the beverage container is tightly fixed.

If the beverage container type and size do not change in the next pouring, all you have to do is follow point “c”, “e” and “f” to place and fix the beverage container.

To prevent the possibility of an explosion, ensure that all of the beverage containers being used have been tested under a minimum pressure of 5 bars (73 psi) and do not have any visible external damages.

To prevent injury caused by accidental glass beverage container explosion, always close the protective door before dispensing.



2

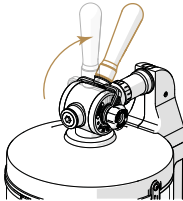

Turn on the carbon dioxide supply by pushing back the dispensing assembly handle until it stops.

3

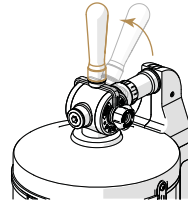

When the sound of the container being filled with gas subsides, return the handle to the upright position and the gas supply will stop.

4

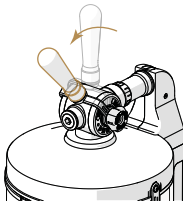

Open the beverage supply channel by pulling the dispensing assembly handle toward you until it stops.

5

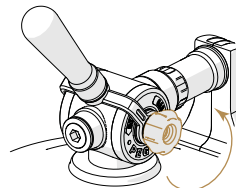

Slightly open the drain channel by turning the flow control valve slowly counterclockwise and the beverage container will start filling up.

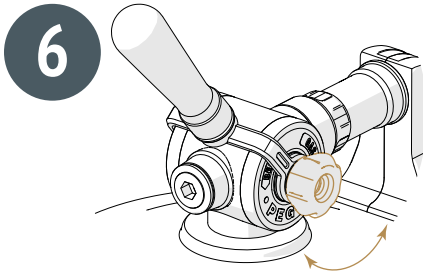

Turning the flow control valve within one rotation, choose the filling speed based on the foam formation intensity.

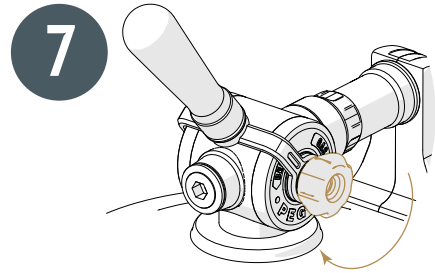

Fill the bottle to just below the desired level and shut off the drain channel by turning the flow control valve clockwise until it stops.

The farther open the drain channel is, the faster the beverage container is filled up and the more intense the foam formation and vice versa. 

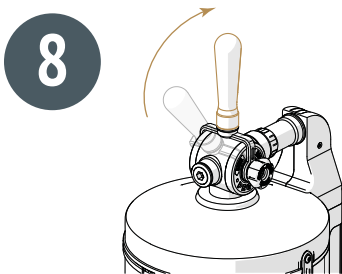

Once you have reached your desired fill line, shut off the beverage supply channel by positioning the dispensing assembly handle upright and the beverage supply will stop.

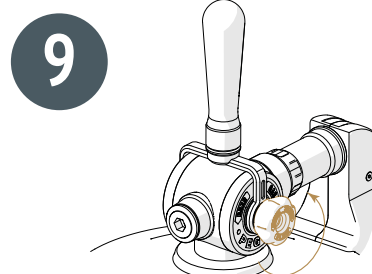

Before releasing the bottle slightly open the drain channel by turning the flow control valve counterclockwise. The pressure in the beverage container takes approximately 10 s to even out with atmospheric pressure.

Intensive foam formation in the process of pressure alignment can indicate that the bottle is insufficiently filled with gas before pouring the beverage or a pouring flow of the beverage that is too rapid. Reduction in foam formation intensity through releasing pressure from the beverage container is achieved by turning the flow control valve slowly clockwise. 

To prevent the beverage from spraying when the beverage container is taken out of the dispenser, do not shut off the drain channel until the intensive foam formation process is over and the foam is drained.

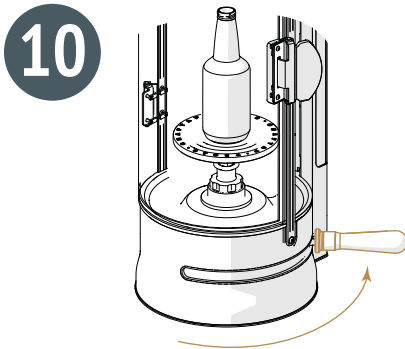

Lower the full beverage container by turning the adjusting assembly knob counterclockwise until it stops, then open the protective door of the dispenser.



Take the beverage container out of the dispenser and close it tightly with a lid as soon as possible to preserve the quality of the beverage.



After each pour wipe the rubber head gasket with **FOOD SAFE** sanitary wipes.

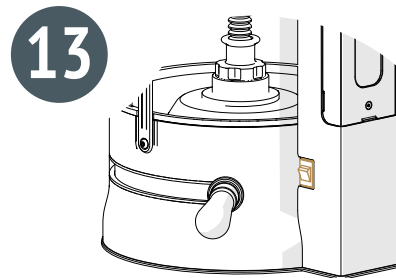

If you do not plan to continue using the dispenser right away, it is recommended to turn off the backlight lamps. This is for energy saving.

Do not forget to sanitize the device daily and weekly to ensure a high quality of the dispensed beverages and to meet hygienic requirements.



# CRAFTAP 3

## Brief Installation and Connection Manual

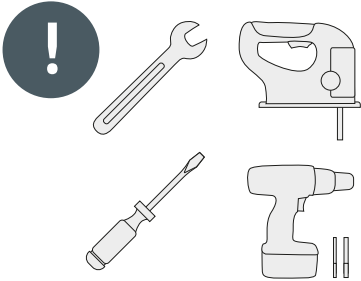

For quick installation you will need:

- a drill with 10, 13, 18, and 70 mm diameter drill bits
- a flat-head screwdriver
- a 13 mm wrench
- 3/8" rigid plastic hoses for the gas and beverage supply and dispensing assembly drain
- a 1/2" rigid plastic hose for the flask drain
- the use of other appropriate tools is also permitted

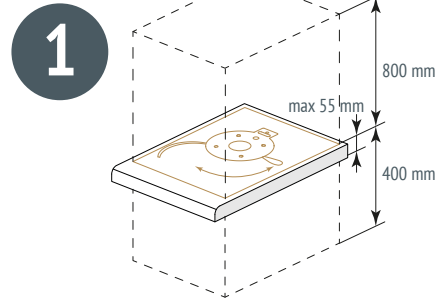

Ensure that the installation location matches the dimensions specified in the picture and indicated on the template. Fix the template and use it to make markings on the table board.

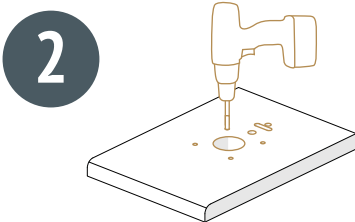

Using a drill and power jigsaw, cut out the holes in the counter top in accordance with the markings.

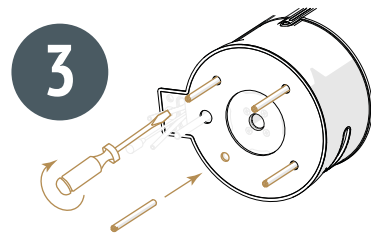

Use a screwdriver to screw studs into the threaded holes in the bottom of the dispenser.

Observe safety rules while using the power tools



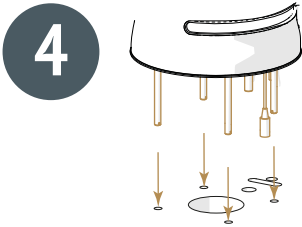

Place the dispenser on the counter top by aligning it with the pre-drilled holes. Insert power cord through rear hole.

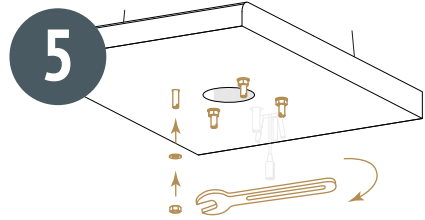

Put on the washers, screw the nuts onto the studs, and fix the dispenser on the table board by tightening the nuts with a wrench.

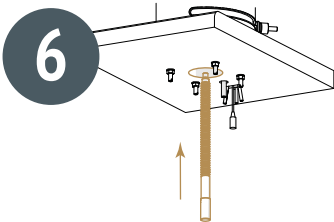

Insert the shaft into the central hole under the counter top so that the threaded shaft end protrudes out of the cam hole.

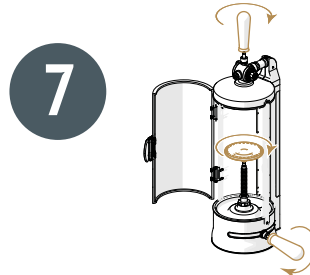

Screw the bottle tray on the end of the shaft with a backing plate on it as well as the handles to the appropriate locations.

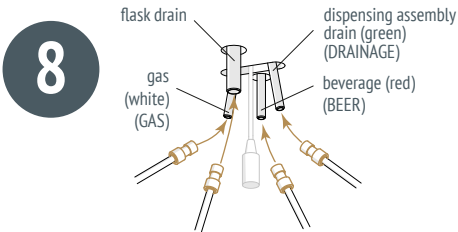

Connect the gas, beverage supply, and drain hoses (flask and dispensing assembly) with the appropriate dispenser tubes using JG-connections included in a standard set.

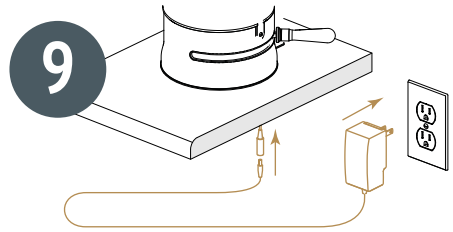

Connect the power adapter to the appropriate device connector under the table board. Connect the device to the power supply line.

Ensure the gas supply from the cylinder is shut off



Ensure that the network settings conform to the dispenser's specifications





# CRAFTAP 3

## Brief Maintenance Manual

In order to ensure smooth operation and performance of all the declared warranty obligations by the manufacturer, we recommend that you regularly maintain your device in accordance with the complete operation manual. The brief information provided can be used as a reminder. We recommend storing it near the dispenser.



## Maintenance program

### Washing: daily\*

	Treatment stage	Flushing agent	Temperature	Exposure time
1	Flushing	Water	60 °C (140 °F)	15 minutes
2	Rinsing	Water	Cold	15 minutes

### Disinfection: twice a week

	Treatment stage	Agent	Temperature	Exposure time
1	Flushing	Water	60 °C (140 °F)	15 minutes
2	Disinfection	Detergent disinfectant-based solution: Sepa Neomoscan and Termit Galo or similar washing and disinfection agents for the interior surfaces of brewing and soft drink industry technological equipment	In accordance with the agent's application manual	15 minutes
3	Rinsing	Water	60 °C (140 °F)	Until there is no longer an agent in the flush water**
4	Rinsing	Water	Cold	

\*The washing frequency is subject to the laws applicable in your country.

\*\*Monitored based on absence of residual alkalinity using universal pH indicator paper.

## For sanitization you will need:

- cylinder with carbon dioxide equipped with a regulator;
- keg for flush liquid, with a recommended volume of at least 20 l (5 gal);
- detergent disinfectant;
- neutral detergent;
- intake head from the beverage keg;
- small volume flush bottle;
- drain tank recommended volume of at least 20 l (5 gal);
- cleaning cloth;
- lint-free cloth;
- soft sponge;
- mini brush with a sponge or soft synthetic bristles;
- flexible flush hose with an outer diameter of 8 mm (5/16");
- latex household gloves.

## Preparatory stage

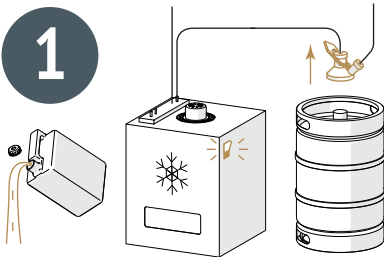

Disconnect the beverage keg from the dispenser and turn off your glycol system if possible. Empty the drain tank.

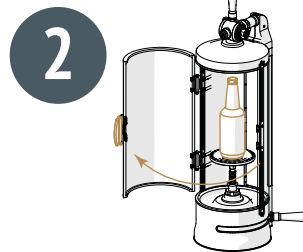

Open the protective door and place an empty small volume flush tank on the tray, having adjusted the adjusting assembly to its height.

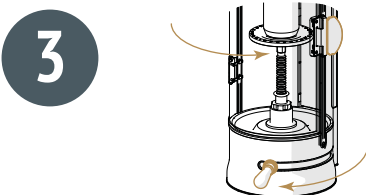

Raise the bottle until tightly sealed with the rubber head gasket and close the protective door.

Do not open the protective door while the flush liquid or detergent disinfectant liquid is being pumped through the dispenser.



## Treatment stage

The sequence of actions specified in items 4-13 should be performed for each treatment stage in accordance with the Maintenance Program.

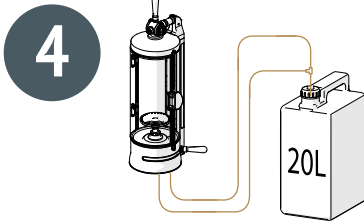

Make sure that the ends of the flask and dispensing assembly drain hoses are placed into an empty drain tank of the recommended volume.

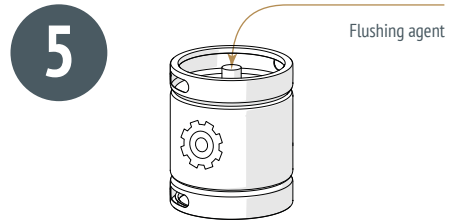

Fill the flush keg with the liquid whose temperature conforms to the treatment stage being performed.

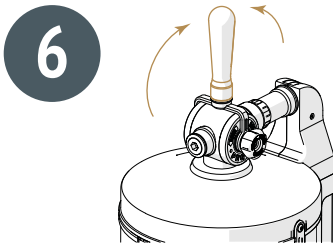

Ensure that the dispensing assembly handle is upright.

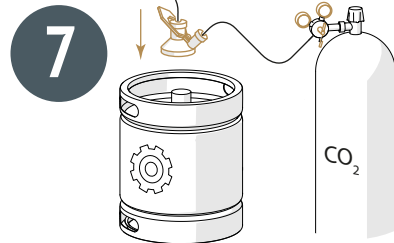

Ensure that the gas cylinder reducing valve is set at a pressure of 1 bar (15 psi). Connect the intake head to the flush keg.

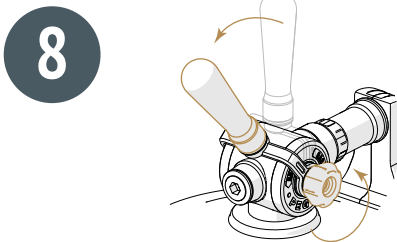

Open the beverage supply channel by pulling the dispensing assembly handle toward you until it stops. Slightly open the drain channel by turning the flow control valve slowly counterclockwise and the beverage container will start to fill up.

In order to reduce flushing agent consumption during the disinfection stage, block the end of the drain hose with a plug and immediately shut off the beverage supply and drain channels. Open the end of the drain hose when the exposure time expires.

9

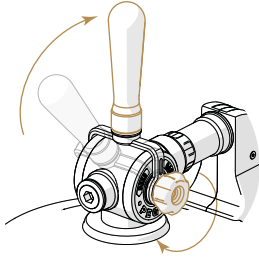

After the performance time of the treatment stage expires, shut off the beverage supply channel and then shut off the drain channel.

10

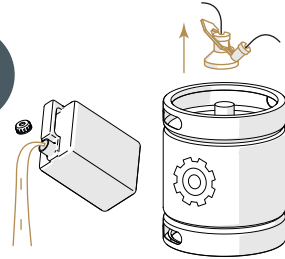

Disconnect the intake head from the flush keg without dismantling the gas and beverage supply channel hoses. Empty the drain tank.

11

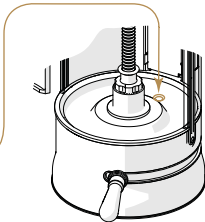

Flushing agent

Pump the flush liquid through the flask drain line conforming to the current treatment stage. The volume of the pumped liquid is 64 oz.

In order to reduce flushing agent consumption at the disinfection stage, block the end of the drain hose with a plug and keep the agent in the drain line for the time of exposure.

12

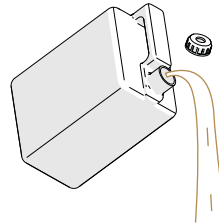

Monitor the fullness level of the drain tank that the liquid is to flow into. When full, empty the tank.

### Final stage

13

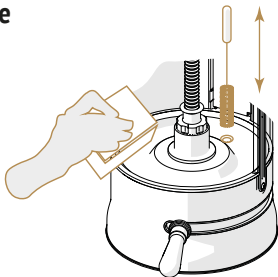

Clean the flask drain channel with the mini brush, then wipe the drain hole with a sponge dipped in warm water with a mild detergent. Rinse with hot water.

14

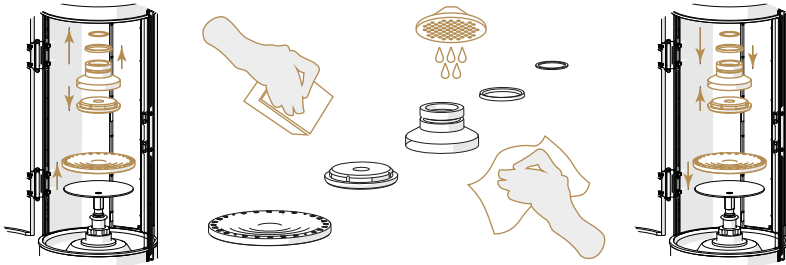

Remove the backing plate from the bottle tray. Twist off the pouring head bushing, detach the gasket, remove the seal from the groove, and remove the gasket from the hole. Wipe the removed components with a sponge dipped in warm water with a mild detergent.

Rinse the parts under running water and wipe them dry with a clean lint-free cloth. Perform assembly in reverse order.

15

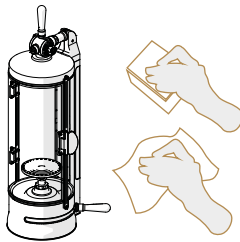

Wipe the inside surface of the flask with a sponge dipped in warm water with a mild detergent. Then wipe the inside and outside surfaces of the flask with a clean wet cloth. Wipe the flask thoroughly inside and outside with a clean lint-free cloth until dry.

16

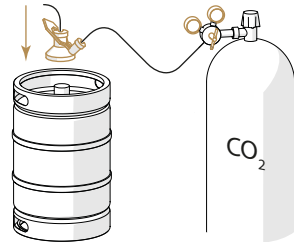

In order to maintain cleanliness, do not drain water used for flushing at the last treatment stage from the beverage supply line until subsequent use of the dispenser. Connect the intake head removed from the flush keg to the beverage keg.

### Before pouring the beverage

Drain the water from the beverage supply line into the empty flush tank. Keep draining the remaining liquid until the beverage starts to flow into the beverage container.

Do not forget to close the door when using the dispenser for dispensing.



Factory serial number
-----------------------

Product name \_\_\_\_\_ PEGAS CRAFTAP 3 beverage dispenser \_\_\_\_\_

Warranty period \_\_\_\_\_ 24 months \_\_\_\_\_

Date of sale \_\_\_\_\_

Name of trade organization \_\_\_\_\_

Full name and signature of the seller \_\_\_\_\_

Signature Name of the signer Stamp here

**CAUTION!**

- While the purchase is being documented, demand that the product's completeness and appearance is checked.
- Make sure that this warranty voucher is filled in fully and properly.

**PLEASE NOTE!**

- A warranty is granted only if there is a warranty voucher and it is completed properly.
- This product is patented. Product counterfeiting and/or the use of a counterfeited product or infringement is punishable by law

**Information on repairs performed during the warranty maintenance period**

Service center:	Service center:	Service center:
Date of receipt:	Date of receipt:	Date of receipt:
Type of repair:	Type of repair:	Type of repair:
Date of release:	Date of release:	Date of release:

Service center employee signature	Service center employee signature	Service center employee signature
Stamp here	Stamp here	Stamp here

**Dear customer!**

NPM, LLC welcomes you and thanks for choosing our products. We are confident that the product you have purchased will benefit your business. This voucher grants you the right to a warranty to repair PEGS brand devices provided that the warranty terms and conditions are met.

**WARRANTY TERMS AND CONDITIONS**

1. This warranty applies to the PEGAS CRAFTAP 3 manual dispensers used in the retail industry for pouring beer and other foamy beverages from kegs into glass bottles.
2. The warranty period of the product is 24 months.
3. The warranty shall cover defects (malfunctioning products) occurring by fault of the manufacturer. Replacement of the defective parts and pertinent works shall be performed free of charge.
4. The warranty shall not cover:
  - 4.1 components of the device exposed to natural wear and tear over the course of regular operation: sealing elements (rings and gaskets); moving elements of the adjusting assembly: slide, slide shaft, rotating bushing socket; and moving elements in the dispensing assembly: cam, stopper;
  - 4.2 casing components: flask, door lock, hinges; in the case damaged or unsuitable beverage containers are used; in the case that gas pressure exceeds the permitted amount, which leads to an explosion of the beverage container in the device;
  - 4.3 electrical elements in the case of the power supply not being restricted at the specified limits (deviation from a current frequency of over  $\pm 0.4\%$  from 50 Hz and voltage exceeding  $\pm 10\%$  from 220V);
  - 4.4 components with damage, cracks ,or scratches caused by any mechanical impact or blow;
  - 4.5 damage caused by foreign objects, liquids, other substances, dirt, etc. inside the dispenser;
  - 4.6 damage to the product caused by the elements, fire ,and other disasters and natural phenomena as well as exposure to aggressive environments;
  - 4.7 damage caused by the product's exposure to caustic chemicals.
5. Warranty repair shall not be performed in the following cases:
  - 5.1 improper operation including a lack of regular washing or unintended use;
  - 5.2 use of the device for commercial beverage dispensing;
  - 5.3 in the case of unauthorized dismantling or attempted repair by unauthorized service centers;
  - 5.4 in the case of illegibility, change, or removal of the serial number on the device base;
  - 5.5 the warranty voucher is missing or is not properly completed (no name and/or stamp from the trade organization and/or signature of the seller, the date of sale), or in the event of the presentation of a warranty voucher of dubious origin.
6. In order to claim replacement of the device or a refund, the following conditions must be met:
  - the presence of the faulty devices;
  - the presence of the warranty voucher filled in legibly, properly, and completely hat contains the factory serial number of the device.
7. After repairs, the warranty period shall be extended by the time that the dispenser is under repair.

**Feel free to send your feedback as well as any complaints as to the dispenser's quality to the manufacturer:**

NPM LLC, PO Box 239, Novosibirsk, 630108, Russia

**Toll-free hotline: 8 (800) 500-73-71**

Tel./ fax: +7 (383) 211-90-49, e-mail: service@npgmgroup.ru

**I have familiarized myself with the warranty's terms and conditions and am satisfied with the completeness and appearance of the product:**

Full name and signature of the buyer \_\_\_\_\_  
Signature Name of the signatory

